

DIGI BASCOM

Calibro a comparazione interno/esterno
Caliper for inside/outside measurement

- Calibro a comparazione interno/esterno
- Corpo lega leggera, asta acciaio inox tempere
- Di facile utilizzo
- Elettronica RS232 mm./inc., water resistant
- Puntali intercambiabili per gole e filetti
- Di serie comparatore 0,01 @ 40 mm e coppia terminali intercambiabili articolo TS 3
- Confezione: scatola in legno

- Caliper for inside/outside measurement with dial gauge
- Lightweight caliper, in hardened stainless steel
- Easy to operate
- Electronic RS232 mm./inc. data output, water resistant
- Interchangeable rods for inside grooves
- Supplied with dial gauge 0,01 @ 40 mm and couple of interchangeable rods article TS 3
- Delivery: wooden case



Article	Range	A	B	Bar Section	Resolution	Accuracy	Code	Kg
DIGI BASCOM 200/60	I 80 - 200	325	55	18 X 4	0,01	0,02	11062	0,600
	E 0 - 138	325	62	18 X 4	0,01	0,02		
Article	Range	A	B	Bar Section	Resolution	Accuracy	Code	Kg
DIGI BASCOM 300/60	I 84 - 300	435	75	22 x 5	0,01	0,02	11083	0,950
	E 0 - 230	435	80	22 x 5	0,01	0,02		
DIGI BASCOM 500/60	I 84 - 500	635	75	22 x 5	0,01	0,03	11085	1,150
	E 0 - 430	635	80	22 x 5	0,01	0,03		

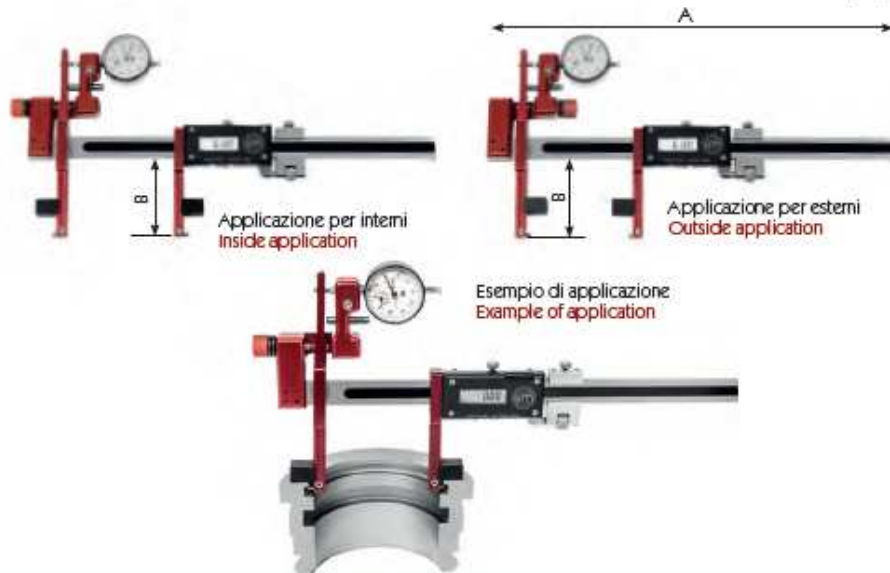
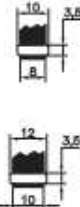

DIGI BASCOM

Calibro a comparazione interno/esterno
Caliper for inside/outside measurement

APPLICAZIONI APPLICATIONS

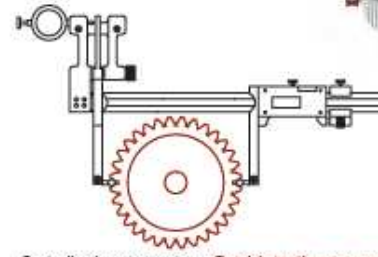

Controllo dentature esterne Outside tooth measurement

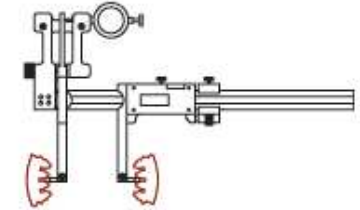

Controllo dentature interne Inside tooth measurement

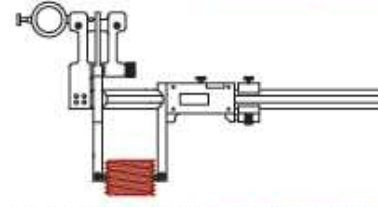

Controllo filettature esterne Outside thread measurement

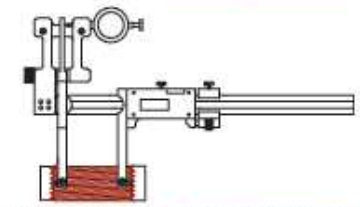

Controllo filettature interne Inside thread measurement

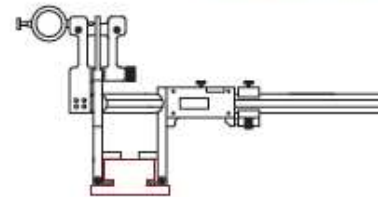

Controllo canali e gole esterne Outside channel and groove measurement

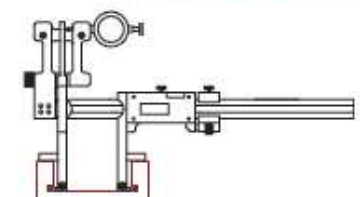

Controllo canali e gole interne Inside channel and groove measurement

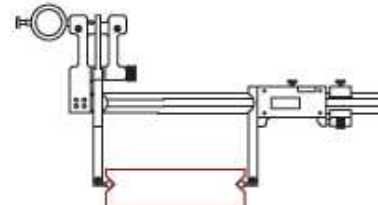

Controllo guide a "V" esterne Outside "V" guide measurement

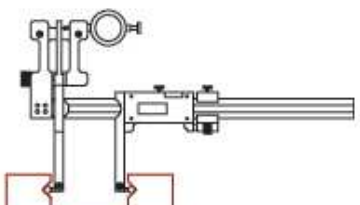

Controllo guide a "V" interne Inside "V" guide measurement

Per i Terminali intercambiabili vedere a pag.104-105 For interchangeable ends see pag.104 - 105